

\$2.00

# Kiai



Aikido Ki Society Australia Newsletter  
Issue Number 1 June 1998



# EDITORIAL

---

by *Tony Deckers*

Hello and a big warm welcome to all the members of Aikido Ki Society Australia, from Mossman in far North Queensland, down as far as Port Augusta in Adelaide, to the first edition of '*Kiai*' for 1998.

It's great to bring you this first issue of *Kiai*. It has been on my mind for almost a year now to do something like this, in a way that we would all be able to communicate and share our experiences and fun times and be able to have something that we can all share and all be a part of.

*Kiai* had it's first beginning's in the early 1990's and was lovingly put together by Carol Booth. Unfortunately Carol's interests took her to Japan and China teaching English. Since the departure of Carol, the *Kiai* newsletter unfortunately came to a stop. But now we're back again!

You may ask yourself what is '*Kiai*' and why call a newsletter '*Kiai*'. Well the name 'KIAI' means to shout with Ki. I hope that this shout will be loud enough to reach all corners of the country, and maybe even further. I am looking forward in the months and years to come to creating bigger and better editions of *Kiai*. This task is something that can only be achieved by the unified effort of all of you, our readers and all the dojo's together. At present it is planned to get an issue out to you every 2 months. There will be a small charge and this is only to cover our printing and mailing cost, probably around a \$2.00 but this might change depending how big the newsletter gets and how many pages will be involved.

As I am sure your dojo instructor has already asked you, I would like to ask again for contributions to the newsletter in any shape of form, and anything that you would like to submit would be gratefully appreciated (*relative to Aikido of course*). Some of the topics I would like to introduce would be things like, personal experiences, whether it be on or off the mat, serious or funny. If you can draw cartoons, any interesting books you may read or may have discovered on Aikido and do a review on it.

As the internet is becoming so big and allows us access to so much information, you may have found a web site that you would like to share with everyone, please feel welcome to let me know, but rather than just sending me information down-loaded straight from the net all the time, we are more interested in hearing from you the reader and the stories you would like to share with us all. I am not only looking for all the serious stuff, I would like to hear all the light hearted stories as well. I would like to including a gossip column, so you can all write about the fun stuff that "*does*" happen within each of our dojo's, so don't let me down !.

Over the past months I have been in constant communication with Sensei Michael & Valarie Williams, on helping me get a starting point and where to go with getting this publication off the ground. They have been a great support, and assisted me in so many ways to help get this first issue up and running. Sensei Michael and Valarie will be contributing something to each of the issues in an various ways and articles.

I hope that by the time you have finished reading this newsletter you will be eager to contribute something toward the next issue. For some of the Dan grades, if you would like to put something from one of your previous grading assignments in, that you would like to share, I would be more than happy to add them in.

So after you have put pen to paper or finger to keyboard, the next question on your lips, is where can you send articles to, well concern yourself no more. With today's technology, it's almost impossible to hide, but you can choose to mail articles to me. (*anything thing you wish returned back to you, e.g.. photo's etc. please enclose a stamped self addressed envelope with your article so it can be returned to you*). You can fax or e-mail them to me or contact me at home or on my mobile phone.

Send all contributions / articles to;  
"The Editor" - 147 Pitt Road, Burpengary 4505 QLD  
Home phone / fax on (07) 3888 1243  
Mobile phone 0419 77 8486 or e-mail me at  
spectrum @ powerup.com.au

I hope you enjoy reading this first issue of our newsletter and look forward to seeing all your articles flood in over my desk during the coming weeks. Remember that the only way we can keep this newsletter going is by your contributions and support to your dojo's by purchasing the newsletter. The dead line for the next issue will be Friday 17th July 1998. The earlier your articles come in the sooner I will be able to get it into the computer ready for printing. If you have any suggestions to what you would like to see, simply drop me a line or preferably an article & I will put it in.

*Yours in Aikido - Tony Deckers*

## To all Ki Society Members,

Welcome to the first issue of the newly resurrected *Kiai* newsletter. The first edition appeared in August 1991 and publication continued until July 1992, when our illustrious editor departed for China.

A very special thank you to Sensei Tony Deckers for his time, expertise and commitment to publish a newsletter which will provide interesting articles, information and most importantly, will be a vehicle to promote unity amongst our Aikido Ki Society Australia Dojos.

To publish a newsletter takes a great amount of time in front of the screen, browsing and editing articles and sorting out distribution. Please support Tony in this worthwhile endeavor. He needs articles written by you and ideas for future issues. The newsletter should be a cohesive voice that represents our group. Beginners and seniors alike all have something to say. Challenge your writing abilities by taking pen to paper and '*put it on the mat*'. Share your thoughts, ideas, questions and visions by writing an article for *Kiai*-the voice of Aikido Ki Society Australia.

Best wishes to all, Sensei Michael Williams



# Tohei Sensei

## Founder of Ki Society

---

Koichi Tohei was born in 1920 and grew up in an upper class Japanese family, north of Tokyo. He was sickly as a child and was introduced to Judo and Zen by his father to try to strengthen his constitution. Later he became involved in misogi and various forms of Japanese Yoga. These events and training shaped much of what was to develop in later life.

In 1939, he met O-Sensei and was introduced to the art of Aikido. He expressed some amazement that despite his Judo training he was unable to deal with this much older man and quickly became a serious student of the Art. In 1942, he was called up to the army and spent time in action in China. After the war he returned to his role as uchi-deshi to O-Sensei, becoming one of the strongest and most influential figures within the Aikido world. In 1953, he was sent by O-Sensei to Hawaii, becoming the first teacher to introduce Aikido to the United States.

Tohei-Sensei rose to the position of Chief Instructor at the Aikikai Hombu dojo and was the only person awarded 10th Dan by O-Sensei and issued with a formal scroll of rank. After O-Sensei's death, Kisshomaru Ueshiba-Sensei became the second Aikido Doshu, and Tohei-Sensei continued to be the Chief Instructor for a few years.

In 1971, while still the Chief Instructor of the Aikikai, Tohei-Sensei founded the Ki no Kenkyukai, to teach the principles of Ki and Unification of Mind and Body, outside the Aikido framework. He later resigned as Chief Instructor and founded the Shin-shin Toitsu Aikikai.

### Ki

The word most frequently used in Aikido is ki. Ki is a very convenient word because it has both a deep meaning connected with nature and a light meaning which is used in daily life. It is very difficult to define ki and even more difficult to translate it into English. Therefore the word ki will be used in the explanation of Aikido.

In oriental thought, it is said that in the beginning there was chaos. The dust of chaos settled gradually to form the sun, the earth, the moon, and the stars. On the earth, the elements combined to become minerals, animal, and vegetable life. We call the chaotic conditions before the universe took shape ki. We say therefore that all things came from ki

Ki itself has neither beginning nor end, nor increase nor decrease. Though it shape was changed, ki itself was never changed. We can see many things around us all made from ki, and when they lose their shape, their elements return to ki. Depending on what you believe, you call it God, or Buddha, or Akua, or some other name.

Aikido is the way of at-one-ment with cosmic power or ki.

That is the deep meaning of ki.

What is the light meaning of ki used in our daily life? A good feeling, a bad feeling, a great feeling, timidity, vigor, courage, a retiring disposition, etcetera - these are terms used in our daily life. In each word or phrase, the Japanese use ki as an integral part. The reason is that a human being was created from ki of the universe. While he receives ki, he is alive. Deprive him of ki and he dies; he loses his human shape. So long as his body is filled with ki and pours forth abundantly, he is vigorous and filled with courage. On the contrary, when his body has run out of ki, he is weak, cowardly, and retiring.

In Aikido training, we make every effort to learn to fill our body with ki and use it powerfully. Therefore, we must understand well the deep meaning of ki.

Koichi

Tohei

"Ki" taken from 'What is Aikido?', Rikugei Publishing House, Tokyo, 1962, page113



"Ki"

Brushed by O-Sensei

### Training Motto

*"Let us have a universal spirit that loves and protects all creation and helps all things grow and develop.*

*To unify mind and body and become one with the Universe is the ultimate purpose of my study."*

*Koichi Tohei Sensei*

# Sensei Michael Williams

## Chief Instructor Aikido Ki Society Australia

Ki Society Aikido. Sensei Deiguelde left South Africa when Michael was a green belt and he and a couple of other senior students struggled to keep the club going without a teacher. In 1978, Michael, his first wife and two daughters, Lisa and Tamara immigrated to New Zealand. There he continued to teach and train in Ki Society Aikido. After commenced the daunting task of building an Australian Ki Society by starting training with one student in a garage. From there, he started a club at Griffith University in Brisbane.

The 8 years in Brisbane were in many ways a struggle-to work full-time and teach Aikido at night, and to save money for the dream of a permanent dojo. During the latter part of the eighties, Michael started searching with intent for the ideal location for his dojo. As many holiday makers can vouch, Byron Bay is one of the most attractive regions in Australia and it was here that he decided to pursue his dream.

Initially, he held weekend seminars in Byron Bay, which were enthusiastically attended and then he left his job, sold his house and moved to Byron in February, 1989. In Byron Bay, he formed the Byron Bay Aikido Club and started the search for affordable land in the area. Because it is such an attractive area, land prices are very high in the region and this proved to be so in Byron Bay.

And now, 18 years on in Australia, the 16 dojos around the country have provided training facilities for thousands of students from all walks of life. A vital component of the growth of Aikido in Australia has been the regular seminars taught by overseas Masters of the art. Goshinkan Dojo in Byron Bay continues to host national seminars, with Nonaka Sensei visiting in June this year and Tamura Sensei this September.

So, Michael's dreams continue to revolve around spreading the message of Aikido in Australia. He is endlessly enthusiastic about Aikido and believes that to introduce people to Aikido is to introduce them to an enlightened way of living. His classes are invariably stimulating, entertaining and dynamic. He loves his students, and this for Michael is what Aikido is all about: love for people .....

*'Aikido is the manifestation of Love'*  
Morihei Ueshiba (O'Sensei)

When Goshinkan Dojo was opened in May 1991, Michael Williams saw the realisation of a long-cherished dream. The dream was to build a centre dedicated to the teaching of Aikido.

The fruition of this dream is a 130 mat dojo built on land 3 km west of Byron Bay in northern NSW. The land adjoins a Melaleuca Wetlands reserve, and has views to Mt. Warning. It is a serene and beautiful setting in which to practice Aikido. There is abundant bird life, all sorts of small furry creatures, wallabies and when the wind is right, the sound of the ocean. Michael lives on the site with his wife, Valerie, their three children and numerous pets. Valerie is a Sandan in Aikido and teaches the children's program, 'Aikikids'.



As with all dreams that are worth achieving, it required hard work, patience with bureaucracy and the determination necessary to survive numerous setbacks for this dream of an Aikido Centre to be realised. Michael Williams was guided by a vision and an obsession to devote his life to teaching what he loves.

Michael was born in Sussex, England, the eldest of a family of four boys and two girls. His father was quite an adventurer and moved his family around, as he became involved in various business ventures. The family went to Africa when Michael was two years old and he grew up in various places in Rhodesia and South Africa. After school, he worked for two years in a bank. Despite this respectable front, Michael led a wild youth, playing in rock bands for twelve years. Partly in compensation, he became a serious student of yoga,

which he practiced for nineteen years. After the bank, he joined a large publishing company in which he held various positions in senior management.

In 1974, Michael worked in New Zealand for Penguin Publishers. That year, he first came across Aikido, when he attended a demonstration by the founder of Ki Society, Master Koichi Tohei. He was very impressed and started training in Aikido in Durban when he returned to South Africa the following year.

Michael's first teacher was Jean Claude Deiguelde, a 5th Dan in





# Nonaka Sensei visits Australia Byron Bay Seminar June 1998

---

Originally, the 73-year-old Nonaka was a kendo enthusiast growing up in Hakalau, just outside of Hilo town on the Big Island of Hawaii. Nonaka sensei first started aikido in 1955, two years after Tohei Koichi first came to Hawaii to proselytize the new art.

When Tohei sensei returned to Hawaii to teach and give seminars and demonstrations. "I was impressed with what he had to say," Nonaka recalls. "I signed up that same night." There followed years of training in aikido, way back when it was seeking to find its own niche in Japan and the West, to when Tohei decided to create his own organization, the Ki No Kenkyu kai, to the present consolidation of the aikido world into various stable organizations.

Being a former judoka, Nonaka could take the falls, and so Tohei used him a lot as uke when he taught on the Big Island. It might have been somewhat of an honor, except that Nonaka was a rank beginner in aikido and didn't know what was going to happen whenever Tohei gestured to grab him. Tohei-sensei would point to his lapel or sleeves, with one or two hands. Okay, Nonaka would figure out that meant grab him with one or two hands. So he did. And then he'd be flying through the air.

This was, after all, when Aikido was still a mysterious art and no one in Hawaii knew much about its methods or its mysterious techniques. Nonaka considers himself fortunate, however, to have been with Tohei when the master was a vigorous 32-year-old, and to have opened his home to Tohei and O-sensei, because he was able to have long discussions through the years with them about the spiritual and philosophical meaning of aikido.

"I could see the change, the development of ki principals (under Tohei)," Nonaka recalls. "At first he was only teaching technique. But over the years, I could see the change. Tohei sensei saw that the way of training in Japan wasn't sufficient. He had a hard time throwing 250-lb. (American) police officers. He went back (to Japan), started thinking about ki..."

"Ueshiba sensei could do all the waza, he could do ki, but he was way above in the clouds. Ueshiba sensei was hard to understand," Nonaka muses. When he told Tohei that he couldn't grasp O-sensei's philosophy, "Tohei sensei told me, instead of trying to listen, watch his movements." What turned the corner for Tohei, Nonaka feels, was meeting a modern-day Japanese mystic, Nakamura Tempu. Famous in Japanese esoteric circles, Tempu is all but unknown in the Western budo world, but his impact on Tohei and Ki No Kenkyu-kai is immeasurable.

"What Tohei was trying to teach was the principal of ki. Ki is like a radio beam, you can direct it," Nonaka says. "Therefore, Tohei sensei's teachings is the waza from Ueshiba O-sensei and the mind part from Tempu. He put it together." In properly executing aikido movements, you should be creating the ki no nagare, the "flow of ki," which Tohei explained to Nonaka as "Like a river, the flow of water. So there is no sharp angle in the river. It makes a nice curve. So we train not to cut the ki."

Nonaka, who was a manager at an agricultural soil and plant tissue

analysis control lab at C. Brewer, retired in 1986. Nonaka and his wife, Toyomi, have two children. Their daughter, Anne Gorden, lives and works in West Covina, Los Angeles, and his son Eric (*a 5th dan*) lives on Oahu, where he is the instructor of the Mililani Hongwanji Ki-Aikido club. Presently, Nonaka is a 8th dan with the Ki No Kenkyukai and serves as chief instructor for the Big Island, with Roy Yonemori as the head of the Hilo Ki-Aikido Club. The club meets at the Waiakea Recreation Center in Hilo town, with instructor classes on Sunday mornings and regular and children's classes almost every day of the week.

Nonaka has visited Australia, New Zealand and Singapore to give seminars in ki and aikido. "Now I appreciate the fact that my father was strict in having me learn Japanese." Not only could Nonaka understand the deeper philosophical and technical side of aikido by understanding his Japanese teachers, but he could also impart that knowledge to English-speaking aikidoka. That, he found, was one factor that was appreciated by his hosts Down Under in Australia, New Zealand and Singapore.

What Nonaka values most from his decades of aikido training is also the fact that "What we learn is applicable and should be applied to daily life. To me that's more challenging than polishing my waza to throw some-body. At my age, I'm not interested so much in the throwing part."

What he learned in a nutshell was, "To learn to relax your subconscious mind and have positive thinking (*attitude*)... It's people-to-people relationship. I could apply that philosophy to management. I managed a lab for 35 years and never had a need to fire anybody. We had expensive equipment. I always assigned the proper person to the proper assignment."

In addition, Nonaka was elated that his cardiologist recommended his patients to take up ki training to learn how to relax. And after speaking to mental health officials, a psychiatrist began to send some of his patients to his classes. Basically, Nonaka says, "A lot of them (*patients*) needed to change their negative thinking. The difference between negative (*thinking*) and positive is paper thin. But when you train together, the whole atmosphere is positive, so you cannot have a negative attitude, so slowly you change the negative attitude to positive."

After listing some other examples of how ki and aikido helped various individuals, Nonaka concludes, "I'm happy to be able to help the community. I'm not interested in teaching 50 young kid to throw somebody."

"Nonaka's training, however, was sorely tested five years ago, when he had knee surgery on both his knees at the same time due to severe arthritis. He had a successful total knee cartilage replacement, although he was not warned to jump, twist or overbend. That has precluded him from doing a lot of Aikido in seiza, but not much else. Nonaka continues to busy himself with a full teaching schedule.

Nonaka analyzes the process of a throw and says, "Before you throw somebody or perform a waza, you should:

- . relax and extend your ki
- . respect your opponent's power
- . find out which way his ki is going
- . put yourself in your opponent's position (or frame of mind);
- . and then execute with confidence.

"You can do that in daily life, dealing with people," Nonaka says. "When people argue louder and louder, they don't want to hear the other person's voice... But try to respect what people can do. Then what direction is his mind going? What is he really talking about? Then try to see his direction, his position, step by step. Put yourself in the person's position, try to understand his point of view. Then lead him. Therefore he doesn't mind listening to you."

Between Tohei's clear concepts and Ueshiba's cryptic sayings, Nonaka realized that aikido went beyond mere physical throwing and pinning people. Once, 0-sensei visited Nonaka's home in 1960 and wandered through the orchid garden. It reminded him of his former home Hokkaido, he said, and then, reflective, he told Nonaka, "Life is like a flowing river. Human beings are in the river. Some are going with the current. Some people swim nicely and others are struggling. He (Ueshiba) would like to help the struggling people, but won't jump into to river. He stays on the river bank and throws in ropes and runs up and down the river (to see if there's waterfall up ahead). If he's in the water with them, he might get caught and can't see the waterfall.

At that time, I didn't understand it," Nonaka says. Gradually, however, he feels he is beginning to comprehend 0-sensei's symbolisms. At another time, in 1968 in Tokyo, Nonaka, his son, and his wife had a private audience with 0-sensei, and he took that opportunity to ask some pointed questions about aikido. Why is there no shiai (contests) in aikido?

0-sensei said, "If there's shiai, there's always a loser. He's not happy,

so he'll get back at you later. So instead of beating a person, winning over yourself (your ego) is harder. So you do keiko shugyo (austere training)." Nonaka also asked, "In Doshu's book (on aikido), he says something about enjoying practice, doing keiko with joy. . ." 0-sensei nodded in agreement. "When you learn something enjoyably, you grasp more instead of when suffering. If you intend to help a student, take uke (the one being thrown)... Uke wa sensei da (the uke is the teacher). Give students a chance to relax, then on move."

That lesson reminds Nonaka of a saying of Tohei's: There are three ways to win over someone: (a) by brute force, but the person will never forget that and will get back at you.. (b) by intelligence. You trick him. Say you dig a hole so that when he attacks, he falls into the hole. But he still won't forget and you can't trick him twice. (c) by winning the person over by showing him respect... But you must show respect first and earn respect from the other side. That's true victory, and it must come from the heart.

That magnanimous spirit is what Tohei calls intoku, which is akin to the Buddhist and Christian ideal of unconditional love or compassion. "So marriage is not 50/50. It's 100%-100%. You give 100% and your wife gives 100%, and so two sides are totaling 200%. I've got to keep reminding myself of that! I have to practice what I preach!" Nonaka admits sheepishly. Still, although retired and favoring his knees, it doesn't look like Nonaka is going to let up on training. "When I go to a new dojo, I thank the people because I'm sharing my experiences, but I'm also learning how to put it across. So those folks are my teachers. If I can be of help, that's the best way I can return Tohei's sensei's favors. What I learned from him, I can pass on to others."

*This Article has been taken and edited from "Flow like a River" in the "Furya" The Budo Journal of Classical Japanese Martial arts and Culture. Spring - Summer - Edition 1995 Volume 1 #4*



# What is a hakama & who wears it?

A hakama is the skirt-like pants that some aikidoka wear. It is a traditional piece of samurai clothing. The standard gi worn in aikido as well as in other martial arts such as Judo or Karate was originally underclothes. Wearing it is part of the tradition of (most schools of) aikido.

The hakama were originally meant to protect a horseman's legs from brush, etc., — not unlike a cowboy's leather 'chaps'. Leather was hard to come by in Japan, so heavy cloth was used instead. After the samurai as a class dismounted and became more like foot-soldiers, they persisted in wearing horseman's garb because it set them apart and made them easily identifiable.

There were different styles of hakama though. The type worn by today's martial artists - with "legs" - is called a joba hakama, (roughly, horse riding thing into which one steps). A hakama that was kind of like a tube skirt - no legs - another and the third was a very long version of the second. It was worn on visits to the Shogun or Emperor. The thing was about 12-15 feet long and was folded repeatedly and placed between the feet and posterior of the visitor. This necessitated their shikko ("knee walking") for their audience and made it extremely unlikely that they could hide a weapon (retainers suited them up) or rise quickly to make an attack.

The 7 folds in the hakama (5 in the front, 2 in the back) is said to have the following symbolic meaning:

- |           |                             |   |
|-----------|-----------------------------|---|
| 1. Yuki   | -                           | courage, valor, bravery                                     |
| 2. Jin    | -                           | humanity, charity, benevolence                              |
| 3. Gi     | -                           | justice, righteousness, integrity                           |
| 4. Rei    | -                           | etiquette, courtesy, civility<br>(also means bow/obeisance) |
| 5. Makoto | -                           | sincerity, honesty, reality                                 |
| 6. Chugi- | loyalty, fidelity, devotion |   |
| 7. Meiyō  | -                           | honor, credit, glory; also reputation,<br>dignity, prestige |

In many schools, only the black belts wear hakama, in others everyone does. In some places women can start wearing it earlier than men (generally modesty of women is the explanation - remember, a gi was originally underwear).

O'Sensei was rather emphatic that EVERYONE wear the hakama, but he came from a time/culture not too far from wearing hakama as standard formal wear.

Saito Sensei tells the following story about hakama in O'Sensei's dojo in the old days:

Most of the students were too poor to buy a hakama but it was required to wear one. If they couldn't get one from an older relative, they would take the cover off an old futon, cut it, dye it, and give it to a seamstress to make into a hakama.

Since they had to use cheap dye, however, after awhile the colorful pattern of the futon would start to show through and the fluff from the futon would start to work its way out of the material.

In "Principles of Aikido", in the section on hakamas, Saotome Sensei mentions that Hombu dojo was quite a colourful place when he was training there, with all colors of hakama. Traditional hakama were not

just solid colors either they often had patterns woven or printed onto them too.

## HOW TO FOLD A HAKAMA

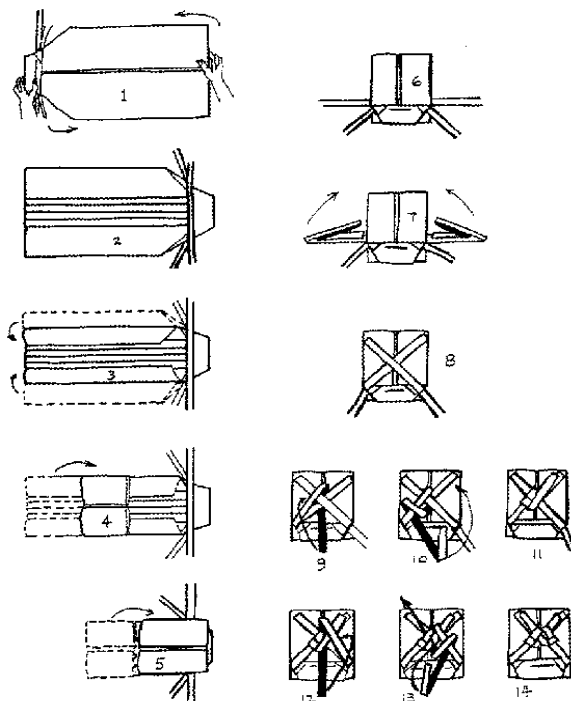

## Pressing With Ki Therapy

### Five Principles for Kiatsu Therapy

1. *Extend Ki from the One Point in the lower abdomen.*
2. *Do not let tension accumulate in your body.*
3. *Press perpendicularly toward the center of the muscle without forcing.*
4. *Focus Ki continuously and precisely at the finger tips.*
5. *Concentrate on the lines, rather than the points.*

In the discipline of Aikido we learn how to coordinate the mind and body through intensive training in the dojo, as well as practicing daily Ki Meditation and Ki Breathing on our own.

For most of us, this means a strong and vigorous body, and a reasonably happy and healthy mind. However, there are many people who, for reasons of sickness, frailty, or ignorance, do not have, or have not had, the opportunity to develop coordination of mind and body.

If they are ill or weak physically, it means that their life force, or Ki power, is at a relatively low ebb. If we are feeling strong and healthy, that means that our Ki is flowing strongly. In the same way that a car with a weak battery needs to have a "jump start" from another car, in order to begin functioning again, a healthy person can help a sick or injured person by giving Kiatsu therapy, or pressing with Ki.....



# Ki Breathing

## Ki No Kokyu Ho

### Principles for Ki Breathing

1. Exhale gradually, with purpose and control.
2. Exhale with a distinct, but barely audible sound.
3. At the end of the breath, Ki continues infinitely like a fading note.
4. Inhale from the tip of the nose until the body is saturated with breath.
5. After inhaling, calm the mind infinitely at the One Point.

*A Zen master once asked his student, "What is the most important thing in Life?" "Truth, Master", the youth replied, without hesitation. The master grabbed the young man's head and plunged it into a tub of water, where he held it for several moments. As the master allowed the student to emerge, gasping for Breath, it became perfectly clear what is the most important thing in Life!*

..... Breath is the key to life. This statement contains truth far beyond the obvious physical reality discussed above. Breathing can control the autonomic nervous system, the system that is responsible for enervating cardiac muscles and glandular tissues as well as governing our so-called "involuntary actions". Next time you become emotionally disturbed, pause to observe your breathing. You will find that, like your agitated emotional state, your breathing has also become shortened and erratic.

When we see someone undergoing some difficulty, don't we always say, "Slow down, take a deep breath, and begin again."? Conversely, if, when we sense a moment of some emotional challenge coming, we are able to calmly continue to breathe deeply and easily. Our autonomic nervous system will mirror this calmness, and those related systems within our bodies will be spared the damage of the avoided stress, not to mention avoiding perhaps some regrettable damaging words or actions.

"Control yourself, before attempting to control others", begins with controlling your own breath, and being able to control your breath only comes through hours, days, weeks, months, years of practice. So, as Suzuki Sensei often says, ' Breathe, Breathe, Breathe!'

.....Excerpt from \* KI-AIKIDO ON MAUI

## Coming Events in '98

### Nonaka Sensei - June 1998

It is with great pleasure that we welcome Nonaka Sensei from the Big Island in Hawaii on his third teaching visit to Australia. We are pleased to announce that Nonaka Sensei has recently been promoted to the level of 8th dan by Master Koichi Tohei. This is a great honour for Nonaka Sensei who has dedicated his life to spreading Aikido and Tohei Sensei's principles. One of the founders of Aikido in America, he is recognized internationally as an expert in teaching Bokken and Jo. Nonaka Sensei is a very special teacher who imparts his knowledge and philosophy of Aikido through his stories, his warmth and wonderful teaching style.

Nonaka Sensei is recognised as a authority on weapons, and will be here in June and will be teaching a weekend seminar in Byron Bay and a weekend seminar in Cairns. He is coming with 9 members of his family to celebrate his 50th wedding anniversary, so agreed to do the seminars while the rest of his family are enjoying their holiday!

<u>Class Times</u>	(morning)	(afternoon)	(evening)
Fri 19th June - 9:00			7:00
Sat 20th June - 7:30	9:30 - 11:30	1:30 - 3:30	5:30
Sun 21st June	9:30 - 11:30	1:30 - 3:30	
<u>Seminar Costs</u>	Standard Student/Unemployed		
Full Seminar	\$120.00	\$ 96.00	
Per Class	\$ 22.00	\$ 18.00	

### Tamura Sensei - September 1998

Tamura Sensei will be visiting Byron Bay again in September 1998. The times that are currently planned for Sat 26th Sept to Wed 30th Sept '98. The next issue of 'Kiai' will have the confirmed times, class schedules and costs.

## New Mascot for Goshinkan Dojo

*Tiger October 1984–March 1998*

Our beloved dojo cat, Tiger passed away on the 18th of March after a short illness. He was known and loved by many students over the years. Tiger managed to charm the most confirmed of cat-haters. He was a shining example of 'keeping one point', as he lay undisturbed in the middle of the mat, while students rolled by only inches away. I always thought he would meet his end by one of those 'off target' tumbles. I feared for the poor student who squashed Sensei's favorite cat! For those of us who trained with him on the mat, he taught us respect, calmness and the heightened awareness that comes from rolling around a live obstacle during training. But most of all we will miss him just being there. I will remember his wonderful character, his nightly vigil of welcoming students to the dojo and his fondness for those crunchy brown beetles.

We would like to introduce our new dojo mascot, Jarrah the Irish setter. Many of you have met the friendly, usually wet and muddy creature already. Most of you are probably wondering if we have had a lapse of sanity in acquiring this beast. The answer is YES! He is unruly, rolls in cane toads and will stop at nothing to get attention. Nothing is sacred around this red devil. He has been known to leap through the car windows of students attending class to steal stuffed animals and anything else that takes his fancy. Yes, Jarrah is a real challenge, but we have grown to love him and have every hope that we will survive his puppyhood and he will grow up to fill his role as dojo mascot with dignity and grace.



# In Memory of Sensei Patrick Pollini

A few years ago, after my first my Sunday morning session at Shizukana dojo, enchanted by the serene beauty of the day (*oh yes, those were the times*), I looked around and said to myself. “Never, as long as I live shall I forget the clarity of this blue sky, the magic of this peaceful day, and above all, the warmth and charming presence of this extraordinary man. We were sitting on the veranda of Patrick’s house, enjoying drinks and lively discussion. Slowly by slowly the other students left, but we kept talking till late at night.

Patrick was born in half French, half Italian family in Paris, September 1949. Short, fat kid with glasses and Italian name (*Pollini*) in post-war France, an outcast, he soon learned, that to fulfil ones bliss, one cannot follow the crowd. Blessed (*or cursed*) with maddeningly questioning mind he left home soon in search for answers. Open to try anything, from sailing around the world as an officer of French navy, pub brawls in Papeete (*Tahiti*), painting and partying in San Francisco, singing and playing leading guitar in a rock band in Germany, or designing car parts and wiring for power stations in Australia.

Patrick’s life was driven by his desire to learn and to understand. And ultimately, to find peace. Because to understand something is to be delivered of it. In his struggle to become, he saw himself as a cross-word grid, aiming to fill as many cells as possible during the time that was given to him, where, as he believed, the last second could have been just the next one. Who am I? Why am I here? How can I help others? Question marks, question marks. Answers? Yes, together with a feeling of futility, because each of them would only induce another question. And hardly any rest. Certainly no peace. Goethe’s Faust expresses the same frustration, when he says: *If on this Earth one moment of peace could I find, then unto that moment would I say “Linger a while, so fair thou art”*

After twenty five years of learning about the principles of body and mind in several styles of Aikido, studying Kyudo and Sumie with various teachers, in different countries, pondering on the third principle, the heart, the unconditional love, Patrick wrote to me;

“There is no doubt about the importance of the heart in order to gain peace. If not to achieve, than at least to come close to perfection, one needs the three elements, the body, the mind and the heart; all of them balanced, applied simultaneously without intention. These are the keys to create the perfect movement, the total harmony with the universe, the ultimate victory. Ki, as we understand it is of the universe. It can be directed, and it cannot be depleted. The more you extend the better it flows. Unconditional love is of the same nature. The more you give, the more comes in...”

*And yet I wish but for the things I have, My bounty is as boundless as the sea, My love as deep. The more I give to thee, the more I have. For both are infinite.* (Shakespeare’s Juliet)

But who teaches the principles of the heart?

“Why is it so, that certain teachers who are, otherwise very skilful and apparently efficient, do not impersonate the love of the universe?” was one of Patrick’s frequent questions. “There are two things I discovered in my lonely quest for the understanding of the unconditional love. First, the attitude of the practitioner is of importance. One should not use the mind to channel the Ki in order to dominate or to show up, but to express love, to unify with the universe, not only to tap into it’s power,

but to melt fully in its kindness and feel the spirit of the creator. If one has this attitude, he can never become a deceit, he loses bit by bit of his ego and grows to be invisible. Are we not supposed to represent nothing in order to avoid conflict with potential counterpart?

The second is the authenticity, the sincerity of the practitioner. Without that, any concept, like -fraternity, equality, tolerance, honesty and so on, as beautiful as they might sound, are just vibration lacking substance, deprived of any value. It is the duty of a philosopher to personify his philosophy, as it is the duty of a teacher to be a living image of his teaching.

Aikido without Ki is nothing, as we know. But even more, Ki without love is not much either. Sending Ki is good! But a loving one, a pure one, totally striped of egotistical motivation. Anyone extending Ki in any other way is like in “Star Wars”, going for the dark side of the force, drifting away from the light.”

The rule on the mat was listen and obey, the rest was full of unexpected. Uncompromising, perfectionist in every way (*you who had the pleasure to train in his beautiful Shizukana dojo know what I mean*). Devoted almost to the point of obsession to awakening the mind and heart in spirit of Aikido, Patrick was prepared to turn his (*and ours*) lives upside down, if that was what it took to live in truth. His teaching methods together with fabulous (*and for beginners rather baffling*) accent were legendary. Following is Patrick’s explanation of kokyu dosa; “*O la Daniel san, don’t fight ze bloke. Love is ze power, not ze muscles. Imagine giving im ze kees*”

Patrick’s skills had never been tested (apart from his rolls in a close encounter with a car) in a real fight on a street. Only once in Germany, returning home from a late concert he was surrounded by a group of muggers, one of them screaming and flashing a knife. Patrick walked straight toward him and patted him on a shoulder; “*Verry good brozer, I am impressed. Keep practicing*”. Needless to say there was no fight, the guys were shocked speechless and Patrick walked away on shaky legs, but unharmed.

My favorite moments were watching him on his tiptoes, hugging and kissing his friends, “*Ca va mon cheri*” and when they sometimes tried to pull away in embarrassment; “*But I love you brozer, what is wrong wiz zat? You Australian blokes are funny, to kees ze fish is normal for you, but touch you and you freak out of your brains. Really, and you call me weird..?*” Funny, warm, with his irresistible French charms, he was usually seen hanging around the kitchen with the girls. “if I think that la femme, a woman, is not equal to a man, it is because I am convinced that she is superior to him, and the day she will get rid of emotional excess that blinds her, she will be able to teach him unconditional love.

Aikido with Patrick didn’t just start and end on the mat. There were



hours of fun on the veranda after each training, and wonderfully warm atmosphere of a small, but close spiritual family, thoroughly saturated with infinite supply of Shizukana homebrew. Patrick, barely visible through a blue cloud of cigarette smoke never said much, and when he did, it was some sort of bull ... But a profound one. Rrreal.

“Delusion or enlightenment! What is the difference? Enlightenment is being awake, aware. Bon. Being aware of ones delusion according to the definition equals being enlightened. Besides, as we know, everything comes from the same source. Everything is one. Therefore these two are not separate concepts anymore, but are also one. “Just eating, just resting, just sitting, just picking one’s nose, and (my speciality), just scratching one’s arse. That’s the big secret”. And what a secret indeed.

In 1996 Patrick left to write and publish the book of his ideas and reflections on Universal love to France. In one of his last letters, before returning home to Australia he wrote to me, “And here is your condensed excerpt of my book.

*When one understands and accepts oneself with the good and the bad, (to deny the physical, the animal within, is to abjure one’s own nature. To understand and to accept it gives the power to control and tame it) everything gets simpler; because conflict disappears. One can identify with all the other manifestations of the universe. When one finds the peace within, one cannot do anything but love oneself. And when one loves oneself, one is able to love everything else; The other human beings, the animals, the plants, the minerals, even things you can feel but cannot see like the wind, or things you can see but cannot touch like stars.*

*This type of love is not; I love you, you love me... I desire you, you desire me... I belong to you, you belong to me ... Focusing love on one person, and because this person loves you back is not love. It is love with interest. It is love for possession. It is not giving. It does not bring lasting happiness. It does not create peace within. It is a misuse of the great love of the universe. The great love of the universe is unconditional. The great love of the universe is compassion. When one can identify with the whole nature, with all the other elements of creation, one becomes aware of one’s importance. One also discovers, that in the eyes of the universe, one is not more important than the smallest grain of sand resting on the beach, nor the spring’s wind fluttering through the willow’s leaves, nor the ray of light that brings the drops of the morning dew on the spider’s web to shine.”*

*Life is a search for awakening, death is a return to earth. What you taught us will stay in our hearts for ever; giving us opportunities to discover the genuine and timeless for ourselves, and to carry this light into the world, I love you too brother...*

*The temple bell stops, but the sound keeps coming from the flowers. (Basho)*

Irena Kalinacova

---

*Thanks to Sensei Michael & Valarie Williams, for the send off they did for Patrick on Friday 27th February 1998. Also for all the people who helped make the evening possible, and also for those who came great distances to make the evening what it was and for giving Patrick a fond and final farewell. We all hope Patrick that you have found the peace you were searching for...*

.....Farewell Sensei Patrick Pollini

## **The Man in the Mirror.**

*If you get what you want in your struggle for self,  
And the world makes you king for a day,  
Then go to the mirror and look at yourself,  
And see what the man has to say.*

*For it isn’t a man’s father; mother or wife,  
Whose judgement upon him must pass,  
The fellow whose verdict counts most in this life,  
Is the man staring back from the glass.*

*He’s the fellow to please, never mind all the rest,  
For he’s with you clear up to the end,  
And you’ve passed your most dangerous,  
difficult test,  
If the man in the glass is your friend.*

*You can fool the whole world down  
the pathways of years,  
And get pats on your back as you pass,  
But your final reward will be  
heartache and tears,  
If you’ve cheated the man in the glass.*

---

## Samurai Creed

I have no parents; I make the Heavens and the Earth my parents.  
I have no home; I make the Tan T’ien my home.  
I have no divine power; I make honesty my Divine Power.  
I have no means; I make Docility my means.  
I have no magic power; I make personality my Magic Power.  
I have neither life nor death; I make An Urn my Life and Death.

I have no body; I make Stoicism my Body.  
I have no eyes; I make The Flash of lightning my eyes.  
I have no ears; I make Sensibility my Ears.  
I have no limbs; I make Promptitude my Limbs.  
I have no laws; I make Self-Protection my Laws.  
I have no strategy; I make the Right to kill and the Right to Restore Life my Strategy.  
I have no designs; I make seizing the Opportunity by the Forelock my Designs.  
I have no miracles; I make Righteous Laws my Miracle.  
I have no principles; I make Adaptability to all circumstances my Principle.  
I have no tactics; I make Emptiness and Fullness my Tactics.

I have no talent; I make Ready Wit my Talent.  
I have no friends; I make my Mind my Friend.  
I have no enemy; I make Incautiousness my Enemy.  
I have no armour; I make Benevolence my Armour.  
I have no castle; I make Immovable Mind my Castle.  
I have no sword; I make No Mind my Sword.



# Words and Phrases

The Virginia Ki Society identifies techniques by their Japanese terms. Because a string of unfamiliar sounds can be intimidating, some schools identify their techniques by number. For example, the very excellent *Aikido and the Dynamic Sphere* contains chapters on such topics as "Immobilization No. 6 against Attack No. 14." This approach eliminates foreign words and phrases but requires serious memorization.

The advantage of using the Japanese names is that once the concepts are mastered the words come apart. Numbers don't. If you look carefully, you will find that the name of the technique describes what you are going to see and do. Names break down into three parts: the type of attack, the technique you will use, and directions on how to move yourself into position. For example, consider *katate-kosa-tori kokyu-nage irimi tobikomi*.

**Attack:** *Katate* is "wrist", *kosa* means "cross" and *tori* is an "attack"; hence this technique deals with an attack to the opposite wrist (his right hand to your right hand). But how will you deal with this attack?

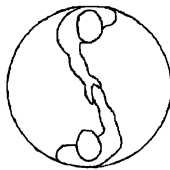

**Technique:** With a *kokyu-nage*. *Kokyu* means "breath" (but may be interpreted as "timing"); *nage* means "throw". *Kokyu-nages* make up a family of "breath-throws", techniques which depend on timing, sensitivity, and Ki extension rather than a joint lock (such as *kote-gaeshi*).

**Approach:** How will you move to begin the technique? *Irimi* is an "entering" motion and *tobikomi* means "jumping in." In this technique, you will move into the attacker's space (rather than around him). Hence, loosely translated, *katate-kosa-tori kokyu-nage irimi tobikomi* means:

*"An attack to the opposite wrist dealt with by entering the attacker's space, leaping into position, and performing a throw based on timing and sensitivity to the attacker's movement and position"*

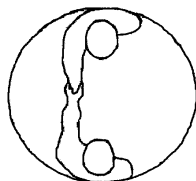

The same attack handled in almost the same way but with an added *kote-gaeshi* is called *katate-kosa-tori kote-gaeshi irimi tobikomi*.

Some words which you will hear from the very beginning are *Sensei*, the 'teacher'; *nage*, the one who "throws"; *uke*, the attacking partner who is thrown; *dojo*, the place of training away, *seiza* the formal kneeling position, *kyu*, "level" (fifth *kyu* is the first adult rank and first *kyu* is brown belt); *shodan*, the first black belt level).

## Symbols

The Japanese symbol for Aikido is the focal point of every dojo and meaningless to untrained eyes. But like words made of letters, kanji (ideograms) are made up of roots and word elements which bring a wealth of concept and meaning to those who can see them for what they are.

**Ai**, *harmony* means to fit, to be in harmony or agreement with. The lower strokes form a square which represents a mouth or opening as of a teapot. The upper three strokes originally formed a lid or stopper. The combination suggests two things which fill together, like the lid on a teapot, the cork in a bottle, the round peg in the Round hole.



**Ki**, *spirit, breath, energy* - Aikidoists think of *ki* as the universal energy or spirit present in all things. The Japanese *ki* symbol comes from the ancient Chinese character for *Qi*, steam, origi-

nally composed of elements representing sun and fire, the sources of steam. In the character at right, the upper three strokes represent the clouds of steam rising from a boiling pot of rice with a lid and handle. The crossed figure within the pot represents a stalk of rice with four individual grains. Together these elements compose a symbol which now indicates vapor, breath, or spirit.



The apparently exotic concept of *ki* has much in common with the ancient Greek *pneuma* meaning air, breath, or wind. This word is familiar in modern English pertaining to air or other gases, or their mechanical properties. But the older, deeper meaning is the animating breath of life-the spirit. In the original Greek of the New Testament, the word which is translated into English as 'spirit' or 'soul' is actually one of two Greek words - *psyche* (also meaning breath and equivalent to the Latin *anima*); Mark, Luke, and John use *pneuma*. And 'spirit' from the Latin *spiritus*, literally means 'breath,' as in 'respiration.'

**Do**, *way, path* - The elements of the symbol represent hair on a human head and legs walking along a path or what, to my eye, appear to be the square paving sections of a sidewalk or street. The combination represents a person walking down a road. *Do* now means a road or path in the literal sense; by extension it means a course of study or a way of life. *Aikido*, the "way of harmony," can be a weekly recreation or it can be a way of life.



- Carol Shifflett. *Virginia Ki Society*  
Reprinted with permission from the *Virginia Ki Society*...."

## We are more than Self.

Behind the temple stood a field in which pumpkins were growing. One day the pumpkins fell into quarrelling. The heads divided into two parties, made an unholy row and insulted one another fiercely.

The good monk who had charge of the temple heard the vulgar brawling and ran out to see what could be the matter. He discovered the pumpkins raging at one another and upbraided them:

'Pumpkins, you must be insane to attack one another like this! Start practicing *Za Zen* this minute!' The pious monk showed them how to practice *Za Zen*: 'Cross your legs, sit there with a straight back!'

The pumpkins did as they were told and what they were practicing *Za Zen* their anger subsided. Then, as peace reigned, the Master said: 'Everyone now put his hand on his head!' They did so, and every pumpkin felt something-extraordinary happening up there above him.

They all found that a living runner went from one to the other, joining them together, and making them one plant. Ashamed of their previous conduct, they declared: 'How very strange, we are all joined together and all live one life together.'

And yet we went quite mad and started fighting one another. How stupid we were! Our good monk is quite right!' And since then the whole colony of pumpkins has lived in peace and amity.

*An Edo Parable*



# Aikido Manifests the Divine Image

Aikido is many things. It has been called a martial art, a physical practice, a self-defense system, a path of personal peace and harmony, a philosophy of life, and a way to spiritual enlightenment.

In my own meditations upon “the way,” I’ve come to appreciate how, for those who have the eyes to see, Aikido opens up archetypal depths. A famous scripture scholar once said that, as a piece of spiritual literature, St. John’s gospel is shallow enough for a child to play in it and yet deep enough for an elephant to swim through. Aikido has the same quality. If one chooses to practice at the level of physical technique, grace and somatic awareness will be the reward. If one delves more deeply in the “way” behind the practice, one can connect with profoundly archetypal images leading toward integration, authenticity, and psychological unity.

In her book *Gods in Everyman*, psychologist Jean Bolen offers a helpful definition of archetypes. “Archetypes,” she notes, “are pre-existent, or latent, internally determined patterns of being and behaving, or perceiving and responding. These patterns are contained in a collective unconscious - that part of the unconscious that is not individual, but universal or shared.” In other words, archetypes are universal images within each of us that carry psychic energy and symbolize experiences common to all humankind.

When we confront an archetype, we experience a profound encounter with the bedrock structure, not only of our own psyche, but of the consciousness that we share with the human race. So properly accessed, archetypes have a numinous, almost converting character. They open us to deeper energies that we might say, using mythic and sacred language, “mirror the divine image.” Author and retreat master Richard Rohr suggests that archetypes lead us into “sacred space,” where we “see” for the first time. When we are in the grip of an archetype, we find vision and a deep sense of meaning for our life.

We experience the presence of archetypes more often than we might think. A common place for interacting appreciation of art and music, the various manifestations of passions and desires, and (as the title of this article suggests) in our practice of Aikido. Through both physical practice and meditation upon its symbols and images, Aikido can lead

us into a more profound understanding of our own depths. I experienced one of these archetypal encounters as I contemplated a picture of O-Sensei standing in prayer. It was almost as though the ground beneath me gave way, and I came to appreciate the transforming potential of Aikido as spirituality.

*O-Sensei seemed to embody at least three archetypes: the Warrior; the Magician, and the Lover.*

While students of archetypal psychology could probably find many archetypal images that pulse through Aikido, three come to mind: the Warrior, the Magician, and the Lover. The Warrior gives us the psychic and spiritual energy for focused, dedicated practice. We can learn to trust the warriors’ energy that Aikido elicits within us, and we can use this focused energy to save our environment, build healthy relationships, and work for justice in our communities.



The Magician opens us up to personal, cultural, and global transformation through the practice of Aikido. The Magician shows us how the paradoxes of life are offerings of individuation and wholeness. There have been stories that show how people are healed of their fear of intimacy by the practice of Aikido. These are stories of the Magician energy at work.

The Lover elicits an unconditional acceptance and appreciation for all of creation. The Lover fuels our psyche with delight and sensuousness, and opens our hearts to embrace the world. Practitioners of Aikido are often reminded of O-Sensei’s desire for Aikido to be an expression of love in the world.

O-Sensei seemed to embody all three of these archetypes. He was a person who could live inside the space of “Budo,” create new martial practices, and see love as the ultimate practice of his art. We would be well served to follow his example. Through our dedicated practice of Aikido, we can allow the archetypes - mirrors of the divine image - to lead us into depth, love, and healing.

*by David C. James Ph.D  
from Aikido Today Magazine*



Having just started to learn Aikido, I had an interesting event occur on a Saturday a few weeks ago. My friends and I went to Lakeside to see the V8 Supercars Qualify. While we were there we went on Dick Johnson’s Bathurst Ride, which is supposed to simulate the Bathurst track. During the “race” my friends were bouncing all over the place, even though they were holding on to rails and struggling to keep in their seats. After we finished the ride they asked how I was able to sit arms folded and not move off my seat the whole time (they didn’t see that I left my seat once at the top of the mountain) and I said I just relaxed as if I was watching the TV at home. They didn’t know that the only other thought was to keep weight underside and extend ki. I was very impressed! Thanks.

*Simon Leonard - Caboolture Dojo*

## “Oh, Aikido, That’s Good!”

When you try to explain why you are so interested in something like Aikido, people can sometimes be at a bit of a loss for words. This doesn’t mean to say that other people don’t understand why you like it so much, it is just difficult to articulate. I have thought of this and it seems to me that to say, ‘you get more relaxed’ or ‘feel fitter’ and ‘more healthy’ doesn’t fully describe why Aikido is so fascinating. Anyone, who has experienced the joys of training in a good dojo though, knows.

When you learn anything, it naturally broadens your horizons for a lot of other things. If you learn a good thing, then it is only natural it will manifest itself in a good way. The important principle of **‘keep one point’** can be the difference between being frustrated or being patient. **‘Relax completely’** can be the difference between having enough energy to complete your daily tasks or being unable to enjoy your leisure time. These principles come naturally to some, but I think many people who have practiced Aikido for a while know what level of understanding these principles can be taken to. Just sitting in seiza for example is of fundamental importance; when you practice seiza even for a short period of time the difference in one’s outlook can be remarkable.

Another example is tumbling, which could make the difference between severe injury or a ‘lucky fall’. Not only that, as Master Koichi Tohei has said, it is “an exercise to unify the body and mind”. ‘Bowing’ is another learned exercise that has effects on the mind that are not

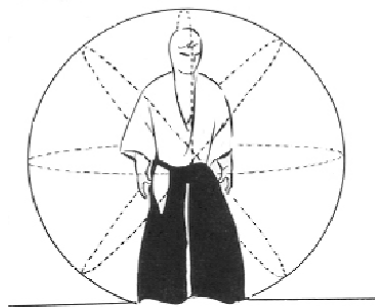

apparent at first. In fact the list could go on and on, the unique thing about Aikido is that what appears soft can be so powerful in its effect.

The exercises learned in Aikido are not difficult, but mastery of them does take time. The beauty of the movements is in the very simplicity of them, unlike some styles of martial training that require high kicks and unnatural movements, Aikido movements appear far more natural and flowing. A relaxed but alert mind and body is the result of good Aikido training. People then tend to develop naturally according to their personality and style. Aggression makes way for ease and stability.

The most fascinating and unique thing about Aikido is the state of mind one adopts to practice. Unlike the common idea of meeting power with power in a clash of heads, Aikido uses the principle of melting into and becoming one with the opponent. Then ‘mind’ plays the key role. Training the mind to be one with the opponent has far reaching implications as time progresses. The martial side of training becomes, as an old oriental saying goes, **“The velvet box that surrounds the jewel inside.”**

Brett King - Byron Bay

## Sensei Michael Williams visits Brisbane

*On Sunday 5<sup>th</sup> April '98* - Sensei’s John Hurly & Steve Dows hosted a seminar at their Spring Hill Dojo. Sensei Michael Williams came up and visited the Brisbane dojo, from Byron Bay. Sensei Williams conducted 2 x 3-hour classes. With around 40 – 50 people for the classes it was a great success.

Sensei Williams visited Brisbane on this trip alone, while his wife Valarie held down the fort (*or dojo*) at Byron Bay. Sensei covered many different attacks & reinforced the principles of one point, movement and calmness.

One of the main points that I learnt from this was to always remain calm in the midst of conflict, and move with the mind and then with the body (*sometimes easier said than done*).

During the last half of the 2<sup>nd</sup> class randori was done covering the techniques we had learnt through the day. It was great to see so many colored belts there and having so much fun with all the techniques. We always enjoy having Sensei Williams visiting us in Brisbane & look forward to the next time we have the opportunity Sensei can come and visit us again.

Dan certificates were also presented on the day to Sensei Graham Brown and Sensei Tony Deckers. Congratulations to Sensei Brown as he was presented a number of his dan certificates. Sensei Tony Deckers was presented his Nidan certificate.

I would like to also thank Sensei John Hurley & Sensei Steve Dows for the efforts they put in to organising Sensei Williams visit to Brisbane for the day and for making everything run so smoothly.

*Tony Deckers Setsudo Dojo - Caboolture*

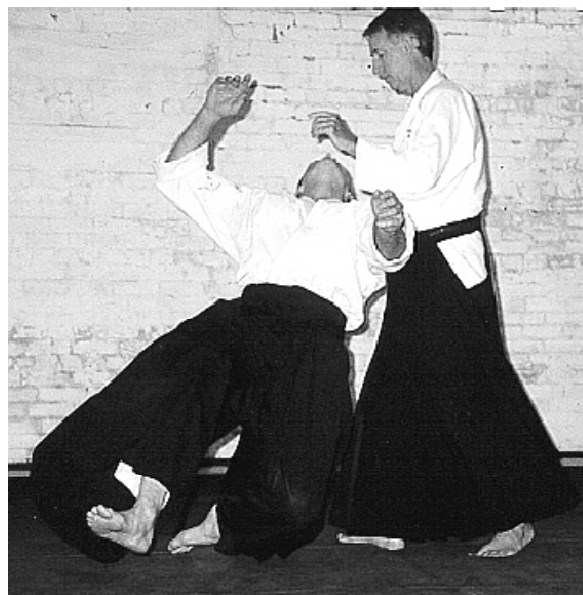

*Sensei Williams demonstrating a technique at the Seminar in Brisbane*

# The Geometry of Aikido - Part 1 by William Reed

---

In the last article I said we'd talk about the Geometry of Aikido, but we'll also get a little physics into the discussion. A more appropriate title then would be "The Science of Aikido." We'll look at some straight lines and when it's important to keep them straight in this most circular of martial arts. We'll revisit the levers of physics class, with their fulcrums and mechanical advantages (or disadvantages). We'll quickly look at triangles and ninety-degree angles to see where they are used. And finally we'll examine circles from several different angles (so to speak).

The first straight line I want to talk about is the one that runs from the top of your head to your one point to the center of the earth. This line is very important. Our bodies are designed for standing upright. When we are standing upright, our weight is supported by our skeleton, i.e., our bones are holding up our bodies. When our bodies are aligned so that the top of our head is lined up with our one point, the balls of our feet, and the center of the earth, we can relax. We don't have to use our muscles to hold us up; our bones are holding us up.

As soon as we lean over, some of our muscles have to contract to keep us from falling in the direction we are leaning. And most of the time when we contract our muscles, we don't just contract them, we tense them, which keeps the Ki from flowing through them. While it's possible to contract our muscles and keep them relaxed, it's fairly difficult for most of us beginners. By keeping our bodies vertically aligned over our one point, our muscles don't have to work as hard to hold us up and can stay more relaxed. We can concentrate on other aspects of our practice, like extending Ki or keeping weight underside.

If we can maintain good posture throughout the technique and let our skeleton do what it was designed to do (hold us up), it will be easier to stay relaxed from the beginning of the technique to the end of the technique. Being relaxed allows you to feel uke's energy and flow with it more easily. You never knew all those years your mother told you to sit up straight and don't slouch, she just wanted you to be a better aikidoist.

The next straight line is the one that runs between your one point and the one point of your uke. In aikido, there are two ways we deal with an attack. We can move around the point of attack (tenkan), or we can get inside the point of attack (irimi). (The point of attack being the point where uke grabs you, the end of uke's fist, the edge of uke's sword, etc.) The quickest way to get inside the point of attack is in a straight line toward uke's one point. (The shortest distance between two one points is a straight line.)

Once we get inside the point of attack, we need to do something. Oth-

erwise, we'll be subject to another attack. Here's where we need to talk about levers, fulcrums, mechanical advantages and disadvantages. First, let's define our terms. The dictionary defines a lever as "a bar or rigid body used to lift weight and operating on a fixed axis or fulcrum." A fulcrum is "the support on which a lever turns in moving a body." We use levers all the time. Every time we move our bodies we are using levers. Our bones are the levers and our joints are the fulcrums (or pivot points). There's also a lever between us and our uke. The lever runs between our one point and uke's one point and the fulcrum is somewhere along that line. Where on that line we put the fulcrum (or pivot point) often determines whether the technique succeeds or fails.

There are mainly three places the pivot point can be. It can be at uke's one point. It can be at the point the two of you have engaged each other, i.e., where you have grabbed uke or uke has grabbed you. The pivot point can be at your one point. So where do we put the pivot point or fulcrum? It doesn't make sense to put the fulcrum at uke's one point. Since the fulcrum is the point the lever moves around (remember our definition - the fulcrum is "fixed" or doesn't move), you would end up moving around uke and only succeed in throwing yourself. If you put the pivot point between you, there is no way to prevent uke from moving the pivot point from uke's side of the lever. So, of course, your one point is the fulcrum. When your one point is the fulcrum, it is immovable. You have control of the pivot point. You have control of your center. You have control of yourself. You have control of uke.

How do we use this lever to gain the most "leverage"? How do we get the most mechanical advantage from this lever? Or the least mechanical disadvantage? I think I'll have to save that discussion for the next article.

So far we've learned the importance of good posture and why we need to keep our bodies aligned so our bones and not our muscles are supporting our weight. We've started our discussion of levers and know why the fulcrum needs to be at our one point. (So we become the calm center of the technique.) Next time we'll finish our discussion of levers and how to use them to gain the most leverage over uke. We'll finish our discussion of triangles, ninety-degree angles, and circles, as well.

Alan Cyr has been studying Ki and aikido since 1990. Let him know what you think of the ideas expressed here. You can stop him in the dojo; he'll be glad to talk to you. You can also e-mail him at the below address. [alan.cyr@ewi.cablew.com](mailto:alan.cyr@ewi.cablew.com)

*from the Virginia Ki Society homepage*

*age*



**STORY OF THE WEEK** Here's a great true story from Japan that recently happened. Best of luck with your newsletter, William Reed.

Tokyo commuter Katsuo Katugoru caused havoc on a crowded tube train when his inflatable underpants unexpectedly went off. The rubber underwear was made by Katsuo himself, and designed to inflate to 30 times their original size in the event of a tidal wave. "I am terrified of water, and death by drowning is my greatest fear," said Katsuo, 48. "Unfortunately I set them off accidentally while looking for a boiled sweet on a rush hour train. They were crushing everybody in the carriage until a passenger stabbed them with a pencil."

# A letter from Logan City dojo

by Sensei Merv Hoole

Well a lot has happened since July 1992. That was the date of the last edition of Kiai. First of all I would like to thank Tony Deckers of Caboolture Dojo for re-starting the wonderful and informative Kiai newsletter. Just looking over the last newsletter I see the second last entry was by the late sensei Patrick Pollini. Patrick was a brilliant instructor who gave me and all who knew him, a lot of guidance in this art of aikido. I also regarded him as a good friend. Thanks also to sensei Michael Williams for giving Patrick a "good send off" on Friday 27th February.

Well I would like to think I have the honour of having the youngest dojo in Queensland. Even though I may be one of the oldest instructors. We have a small (average 8 - 9 students a week) but very enthusiastic group. At this stage I would like to congratulate John Kowjoski for successfully completing his fifth kyu. Our very first grading !

Also I would like to thank sensei Graham Brown 4th dan and also Robbie Feasey 1st dan, for supporting our dojo and giving me guidance when ever I need it. Their support greatly helps the smooth running of our dojo. It is great to see students (and friends) from visiting dojos coming along to practice with our group from time to time. I know my students appreciate it too. Some have to travel up to an hour to get here on a regular basis - thanks Jimmy. Logan dojo started on November 10th 1997 and it is now our sixth month in operation. Thanks to Mike Stoopman for helping me start it off.

Well the Easter break is about to start as I write this article so I wish everyone a safe and happy Easter, hope you get heaps of eggs. Oh! by the way our location is the police citizens youth club in Logan central (corners of Jacaranda and Wembly roads - Woodridge). Our classes are 7.30 - 9.00 Mondays and Wednesdays. There is also a children's class on Saturday morning.

For any more information contact me on (07) 3200 5390 any time. So until next time keep extending Ki. See-ya !

Merv Hoole Sensei - Logan City Dojo.

## Japanese Words for the day...

- good morning - o-ha-yo-gozimasu
- good afternoon - konnichi wa
- good evening - konban wa
- good night - o-yasumi na-sai
- goodbye - sayo-nara
- please - doka

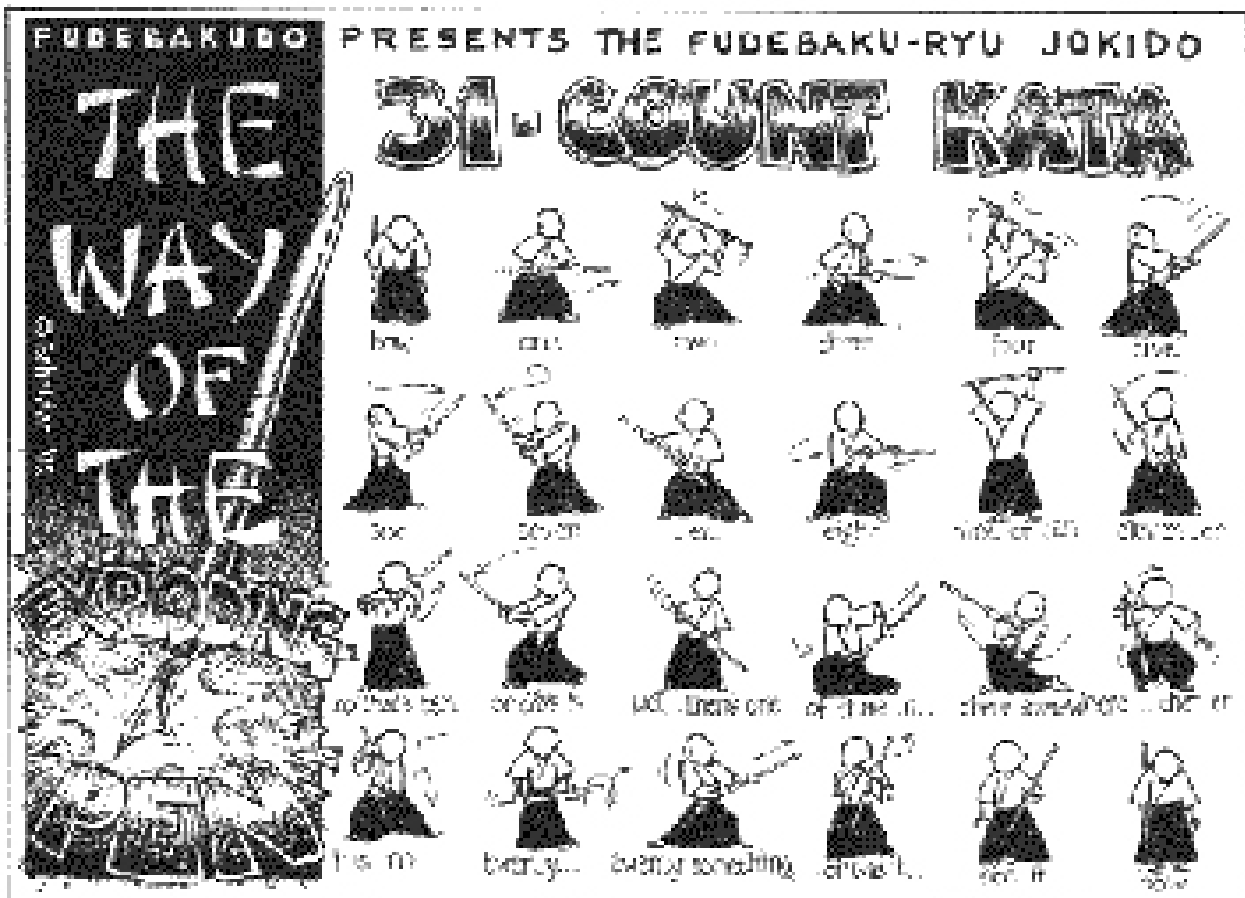



## The Comfort Zone

From those hired halls and warehouses to the intimate handbuilt dojo in the hills, The Dojo is a special place. Some people feel it at their first class. For others it happens at some point on our Aikido journey. It is hard to define that point in time, when it becomes more than a building, more than a social outing, more than a mysterious place we are drawn to.

Growing up in the bible belt of the Southern United States, I was used to visiting churches. My Dad liked Churches. It didn't matter what faith, he just liked the atmosphere. Maybe he was searching for God or maybe he just liked watching people, I'm not sure, but I think mainly he liked being part of a community. Belonging to a group of people who he felt were on a path with good values and caring support. Anyway, I got dragged along to lots of them over the years as I grew up. From the energetic holy roller churches preaching fire and brimstone to the beautiful ones, with stained glass and steeped in tradition.

The idea of '*going somewhere*' for spiritual development felt pretty natural to me. Kamiza, Hakamas and those Japanese words took some getting used to, but outside of that, it wasn't long before the dojo started feeling like my 'church'.

It wasn't the techniques or the physical workout, but the '*not always easy to grasp*' philosophy that went along with it. I rejected the idea of a God I couldn't see a long time ago, so I was surprised how easily I grasped the concept of '*Ki*'. After all, I couldn't see it and had to believe in it for it to work. I had to call on that intangible element called '*Faith*' that they used to speak about in Church on Sundays, to believe in my Sensei when he said it would transform my life. He told me that caring, compassion, strength, sensitivity and increased awareness of the world around me was woven into every technique. He said it would take 6 months before I began to see changes..

We put a lot of trust and faith in our Senseis in our early days. Maybe it's the smiles on the faces of those seniors who help us through our infancy or maybe we just pick up on the energy of the dojo, but it happens. Like magic, this art we practice, becomes a pillar of strength in our lives. A comfort zone, a place of belonging, a refuge from our daily woes. The dojo is where we refresh our outlook and get a dose of positivity and fun in our lives.

Remember when you were a kid and you went to the park to play. Often you would meet kids there and play all day with them without ever asking what their name was. After 10 years that still happens to me on the mat. I like that feeling of names and identities being unimportant. It is the place I feel most like me. Where you are not defined by what you do, who you are or even how you are. Training becomes an exciting, interesting, dynamic exchange of energy between all those on the mat. Without the 'who, what or how', we are really free to experience '*play*' again. It brings us '*into the moment*', bringing to light in a positive way our strengths, weaknesses, habits and attitudes.

Instead of reading the Good Book or trying to be a '*good person*' like the preacher said, Aikido gives us the vehicle to change ourselves into the person we want to be. I'm still not sure how it happens, but changes do happen. Our perception of the world changes. We learn that we are responsible for our actions. We learn new ways of thinking which allow us to live life positively and with caring and compassion for all around us.

The dojo is my comfort zone. Even when I lose the plot, it is there. There is an honesty that happens between those who have trained together for years. That honesty shared by those who train together is really special. It makes us sensitive to others and helps us to see

others and ourselves more clearly. I really like all the different sorts of people I meet on the mat. I share a special fondness with the old ones and I love having beginners on the mat too. They are refreshing, enthusiastic and they usually teach us far more than we teach them.

Our Senseis teach us commitment through the example of the commitment they show. To open a dojo takes great determination, commitment, time and energy. A Sensei has to have faith too. Faith that students will come to learn. Faith that Aikido really does offer something special.

I'm really grateful for my Sensei, who not only teaches me those wonderful techniques, but who is like a tree of support through which the sky looks more blue and I can see the leaves dance like Ki in the wind.

Sincerely, Valerie Williams Goshinkan Dojo

Please support one of our special Senseis, Tony Deckers in his efforts to establish this newsletter. The newsletter is an important way to bond our Aikido community and provide a voice for our minds and hearts.

---

## Noosa Hinterlands

### Boreen Point Weekend Seminar

On the 15-16 & 17th of May this year Sensei Kate Coupe from the Noosa Hinterlands Dojo hosted her Inaugural Boreen Point seminar which was a great success! Sensei Michael Williams conducted the senior classes while Sensei Valerie Williams and Sensei Kate Coupe conducted the children's classes on the Saturday and Sunday mornings.

Sensei Kate did a wonderful job of preparation for the weekend, to make us all feel comfortable and relaxed. With the weather being not so favourable for early morning beach practice, we ended up doing bokken training in the hall over looking the wonderful views of '*Lake Cootharaba*'. With people coming from Byron Bay, Griffith Uni, Spring Hill & Caboolture dojo's, and with around 25 people per class made for a happy and light hearted atmosphere not only during class and also outside of class.

The accommodation where we stayed was '*second to none*', and at only \$10.00 per person it was a '*steal*'. There were spacious cooking and shower facilities available and the bedrooms were so popular that people were racing to get one. One of the Byron Bay students (*Warren*) was one of the first in and managed to get the only room that provided in-ground ventilation. It just shows you have to be the early bird that gets the worm! With the facilities so popular some of us were not happy to find other another place to stay, but just squeezed more into one room and in one case into one bed ???

After our morning weapons class, we all bombarded the corner shop for breakfast. The shop owners were not prepared for such an influx of customers at one time, especially breakfast time. Since there was plenty of time between classes, breakfast was where we all had the chance to talk and relax.

After the Saturday evening class, we all went to the local Hotel Bistro for a wonderful dinner, and then headed over to Kate's home for the rest of the evening to relax to enjoy ourselves. The weekend was a great success & thanks again to Sensei Kate for inviting us all up to her neck of the wood for a great time.

Tony Deckers - Caboolture

# Aikido Humor

from AikiWeb Humor:

**Ukemi** - The history of ukemi: A big fat bully was really tired. He saw a skinny little guy who looked like he had a lot of energy. He grunted "You carry me" as he went to climb aboard the hapless fellow's back. The skinny little guy executed a perfect forward roll. Being too focussed on the predicament in which he had found himself he never did make exact sense of what the bully said, replying "ukemi, indeed!" as he walked away. And to this day we call our rolls and falls "ukemi" in his honor.

**Tai Sabaki** - Similarly, "tai sabaki" results from the mis-hearing of "Thai souvlaki," which everybody knows is actually Satay, or chicken on a skewer; the significance is that in olden days if your footwork was done chicken-toed, the teacher would skewer you. Nowadays they just glare.

**Aiki-Just-So** - For the finicky; they never progress past ikkyo because nobody ever does it well enough.

**Bikido** - Developed by bicyclists tired of being run off the road; the only style that does a "true" kaiten-nage.

**Boo-do** - Stealth techniques, possibly ninja-influenced, in which uke initiates attacks by leaping out of hiding with a shout.

**Haikudo** - Appeals to enthusiasts of Japanese culture who cannot decide if they prefer to study poetry or martial arts.

**Reikido** - Integrates body work and body arts in one discipline so you can throw your back out and put it back into place in the course of one technique.

**Tushie-nage** - This technique is never taught, but beginners invariably discover it the hard way.

**Baptism-nage** - Kaiten-nage done in a body of water. Potentially lethal.

**Ten-pin-nage** - Randori against ten attackers in a long narrow dojo, scored as in bowling. "Strikes" do not mean "atemi" in this application....

**Jujube-nage** - Uke is distracted by offers of candy, then thrown hard; likely inspired by Dr. Who Sensei and his famous "jelly baby atemi."

**E-I-E-aido** - The Old Macdonald style; the art of live blade drawing and quartering, with livestock as uke.

**Go-flya-kaitenage** - Technique in which uke is projected out of the dojo, outdoors into a thunderstorm (with Ki of course). First cited in Poor Richards Alamaaikido.

**Cacciattori Chickennage** - Italian dish prepared one-handed by Aikido-Listers being tested for rank

**RyeOatTandori NoChickennage** - East Indian vegetarian variation of the above.

**Rant-ori** - Multiple verbal attackers (when performed seated, known as "Seiza Who?")

**Tai-No-Hankie** - Basic technique for blending your nose with the sleeve of your gi.

**Rokyo** - You will be pinned by a drunk chanting "We will rock you"

**ChiChikyo** - You will be pinned by a high-heeled nage in a Chanel gi.

**Queuekyo** - You will be pinned by a whole line of people

**HeyManUchi** - Attention-getting strike

**HeManUchi** - Repeated strikes, closed fists alternating, to one's own (hairy) chest

**LikeCoolManUchi** - Left-of-center strike to the bongos

**YesManUchi** - Strike with a rubber stamp

**NormanUchi** - Sat next to me in third grade

## The Way of Love - Tantric Aikido

Many don't know about it, but there's an esoteric side of aikido - tantric aikido. Don't forget that "ai" can be translated as "love" and so aikido also means The Art of Making Love. The principles of aikido can be applied on the mat as well as in bed. ... I know, I know - why limit ourselves. I guess, I should say: on the mat, in bed, on the sink, on the back seat of a car, on the bus station, in the gutter, etc. Whatever the case may be, universal is universal - it goes any time, any place.

*Consider the following 12 universal Love (Ai) principles:*

1. When you find the opening, enter!
2. It is preferable to enter deeply and from behind.
3. Change partners often, but keep the Sword in a sheath, for safety purposes.
4. A little bit of pain can be useful and stimulating.
5. Brute force is not important - technique is.
6. It's not important how big your Sword is, but what you do with it.
7. Practice daily, if you can;  
*Young people (15 to 35) should engage everyday,  
Middle-aged people (35 to 60) 3-4 times a week,  
Elderly people (over 60), twice a week.  
Kids (15 to 18) should practice with each other only.*
8. Make your partner relaxed and comfortable - otherwise she won't be able to respond properly.
9. Solo sessions are OK, but group sessions are more satisfying.
10. Foot techniques are possible (although a bit esoteric) while hand techniques are the norm.
11. You can also do it on your knees.
12. Don't rush with the technique. Timing is everything!

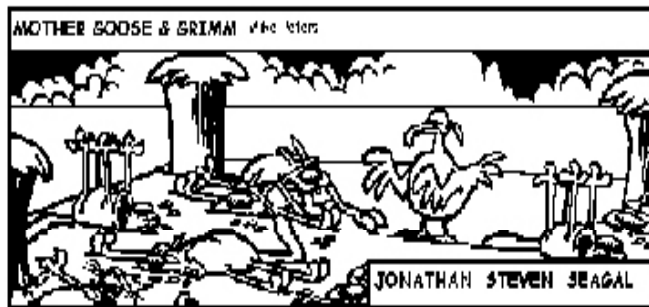

## Thought of the day!

*Yesterday is the past,  
tomorrow is the future,  
today is a gift...  
... that is why we call it the present*

*Unknown*



# AIKIDO KI SOCIETY DOJO DIRECTORY



## NEW SOUTH WALES

### ***Aikido Ki Society - Byron Bay Dojo***

Head Dojo Instructor - Michael Williams  
PO Box 412 Byron Bay, NSW 2481  
Phone: (066) 856 389  
e-mail: aikido@om.com.au

### ***Aikido Ki Society - Uki Dojo***

Head Dojo Instructor - Steve Phillips  
Lot 28 Bonnydoon Rd. Uki, NSW 2484  
Phone: (H) (066) 795 091 (M) 015 586 583  
e-mail: phillips@norex.com.au

## QUEENSLAND

### ***Aikido Ki Society - Mareeba Dojo***

Head Dojo Instructor - Alfio La Spina  
Lot 32 Warril Drive, Kuranda Qld. 4872  
Phone (07) 4093 7237

### ***Aikido Ki Society -***

#### ***Cairns Dojo/Mossman Dojo***

Head Dojo Instructor - Roby Kessler  
PO Box 413 Mossman Qld. 4873  
Phone: (H) (070) 982 722 (M) 015 159 447

### ***Aikido Ki Society -***

#### ***Cooran Dojo/Boreen Point Dojo***

Head Dojo Instructor - Kate Coupe  
7 Hector st, Boreen Point Qld 4571  
Phone: (07) 5485 3028

### ***Aikido Ki Society -***

#### ***Setsudo Dojo - Caboolture***

Head Dojo Instructor-Tony Deckers  
147 Pitt Rd. Burpengary, Q. 4505  
Phone/Fax: (H) (07)38881243 (M) 014 977 8486  
e-mail: Spectrum@powerup.com.au

### ***Aikido Ki Society - Spring Hill Dojo***

Head Dojo Instructor - John Hurley  
100 Bowen Street, Spring Hill, Brisbane Qld 4000  
Phone: (07) 3832 1671  
e-mail: n.ricketts@cat.csiro.au

### ***Aikido Ki Society - Cleveland Dojo***

Head Dojo Instructor - Thom Hansen  
135 Boundary Road, Thornlands Qld 4164  
Phone: (H) (07) 3206 1772 (W) (07) 3255 0666  
(M) 041 902 3700  
e-mail: thansen@tpgi.com.au

### ***Aikido Ki Society - City Hall Dojo***

Head Dojo Instructor - Michael Conroy  
GPO Box 1852 Brisbane, Q. 4001  
Phone: (H) (07) 3358 4322 (W) (07) 3403 3338

### ***Aikido Ki Society - Griffith University Dojo***

Head Dojo Instructor - Michael Stoopman  
PO Box 842 Springwood, Brisbane, Q. 4127  
Phone: (H) (07) 3841 4848 (M) 041 878 2259  
(W) (07) 3406 4113  
e-mail: MStoopman@qmcsbne2.telstra.com.au

### ***Logan City Dojo***

Head Dojo Instructor - Merv Hoole  
8 Catalina St, Loganlea Qld 4131  
Phone (H) (07) 3200 5390  
P.C.Y.C Logan central

## SOUTH AUSTRALIA

### ***Aikido Ki Society -***

#### ***Port Augusta Dojo/Whyalla Dojo***

Head Dojo Instructor - Mike Loran  
13 Waters Crescent Port Augusta, SA 5700  
Phone: (086) 423 877  
e-mail: Tuddy@dove.net.au

*Note: If your Ki Society Dojo listing is not here and would like it added to the list please send all detail to "The Editor" for Dojo Listings.*

